

Technical Notes Vol. 1, No. 2

70-Volt Distribution Systems Using JBL Industrial Series Loudspeakers

Theory of Line Distribution Systems

In a typical paging, background music, or noise-masking system, many loudspeakers are placed across a single amplifier. They must often be powered at different levels, and the calculations involved in determining the actual load impedance at the amplifier's output are quite tedious. The 70-volt distribution system was developed to make all calculations simple and straightforward. In this method of distribution, the output of an amplifier is designed so that its full power output exists at a voltage of 70 volts RMS, as shown in Figure 1. Table I shows the load impedances which correspond to several output power ratings.

In application, many loudspeakers are placed across the output using distribution transformers, which matches the load impedance of each loudspeaker so that it will draw a specified amount of power from the line. Figure 2A shows a typical distribution transformer which has two primary taps (for different line levels) and multiple secondary taps for different power drives to the loudspeaker. Figure 2B shows a different transformer arrangement, which power settings made in the primary and loudspeaker impedance matching in the secondary. The configuration at A allows the same transformer to be operated with 25-volt systems, while the configuration at B allows the same transformer to be used with loads of different impedances. Both types provide identical turns ratios when used in the 70-volt-8-ohm configuration.

Let us assume that we want to drive a particular loudspeaker at 5 watts. The connection is made as shown in Figure 3, and the impedance of the loudspeaker as seen from the primary side is calculated as shown. Note that the 8-ohm loudspeaker is transformed across to the primary as a 1000-ohm load to the amplifier. The 70-volt primary has, in the process, been transformed down to 6.3 volts RMS at the voice coil.

Loudspeakers are placed across the line and tapped as needed, and all the designer has to do is simply count watts. When the total wattage drawn by the line equals the power output rating of the amplifier, then the proper load will exist at the amplifier's output. The simplicity of the method is that the user need never calculate load impedances and their parallel combinations.

Use of the 25-Volt Tap

Just as a 70-volt amplifier produces its full output at 70-volts RMS, a 25-volt amplifier produces its full output at 25-volts RMS. Because wiring codes do not require conduit for voltages up to 25-volts RMS, the 25-volt system has been incorporated into some distribution systems, particularly school systems. Assume for example that we have a 200-watt amplifier with a 25-volt output. Then the load impedance for full output will be:

$$Z = E^2/P = (25)^2/200 = 3.13 \text{ ohms}$$

Transformer and Line Losses

70-volt line-to-loudspeaker transformers in the 5-watt class should exhibit nominal insertion losses no greater than 1 or 1.25 dB, and the frequency response should be uniform from 40 Hz to 12 kHz. The distortion should be less than 0.1% at mid-frequencies, rising to no more than 5% at 40 Hz. Figure 4 shows a schematic of the JBL 9315HT transformer designed to be used with the JBL 8000-series of industrial loudspeakers. Table 2 gives the published specifications for this transformer. Measurements on an actual production unit are given in Table III, and for comparison we show, in Table IV, similar measurements on a Soundolier Model HT-47 transformer. The transformers are comparable except for the total harmonic distortion (THD) at 40 Hz at high drive levels.

Wire losses in 70-volt systems should be held to no more than 0.5 dB. The trade-off here is obviously between the cost of power and the cost of copper wiring. Actually, the losses at the loudspeaker come from two sources: power loss in the lines and power not delivered by the amplifier due to the load mismatch. The data presented in Table V gives the maximum length of wire pairs that will ensure losses in a 70-volt system not exceeding 0.5 dB.

We can use Table V to determine maximum wire runs for different gauges in 25-volt systems by:

1. Dividing all lengths by 8
2. Dividing maximum safe power by 2.8
3. Dividing the load impedance by 8

Loudspeakers Used in Distributed Systems

Because they are generally low-power units, and used in relatively large quantities, loudspeakers used in low-level distributed systems tend to be selected on a very competitive basis. It is not unusual to see equivalent models by several manufacturers priced within pennies of each other. While there is certainly justification in not using costly cast frame loudspeakers for paging systems, there is absolutely no reason why performance characteristics have to be compromised to the extent usually seen in this segment of the professional sound industry. JBL's 8000-series industrial grade loudspeakers are both cost competitive and, as will be seen, show a performance edge over the general level of competitive products:

100 mm (4") diameter loudspeakers

The curves shown in Figure 5A, B, and C show the performance of the JBL model 8110 loudspeaker. Note at A the smooth response through the mid-range. The on-axis rise above 4 kHz is generally beneficial in that it is

associated with maintaining extended power response out to the 6-8 kHz region. The off-axis response is shown at B. Second and third harmonic distortion for 10-watts input is shown at C. The distortion in this figure has been raised 20 dB for ease in reading. Note that above 400 Hz the distortion components are in the 1 to 2% range.

Figure 5D, E, and F show equivalent measurements for the Soundolier model FC-104, and Figure 5G, H, and J show equivalent data for the Altec model 405-8H. Note that both competitive models show a considerable dip in their output in the 800 Hz to 1500 Hz range. These dips, which are almost an octave wide, occur in the frequency range so important to speech articulation. They are due to improperly controlled surround resonances in the loudspeakers. The off-axis behavior of all three models is equivalent, since it is basically a function of cone diameter. Distortion data for the the Soundolier and Altec models shows a rise in the 400 Hz to 4 kHz range relative to the JBL 8110H.

200 mm (8") diameter, 142 g (5 oz) magnet, loudspeakers

Figure 6A, B, and C present data on the JBL 8120H, while D, E, and F and G, H, and J show data, respectively, on the Soundolier model FD and the Altec 2549A. Note the smooth mid-range response of the JBL 8120H as compared with both competitive models. Off-axis behavior of all three loudspeakers is equivalent, since they are all single cone designs. The 10-watt distortion performance of the JBL 8120H is marginally better than the Soundolier FD and significantly better than the Altec 2549A.

200 mm (8"), 283 g (10 oz) magnet, loudspeakers

Figure 7A, B, and C present data on the JBL model 8130H, while D, E, and F and G, H, and J present data, respectively, on the Soundolier model C10 and the Muzak C8M10/U704. Again, note the overall smoothness of the JBL model compared to the other two. Off-axis performance is again similar between the models. The distortion performance is unusual. The JBL model shows fairly constant distortion in the range from 400 Hz to 10 kHz. The Soundolier and Muzak models exhibit extremely low distortion in the range from 200 Hz to 800 Hz. Above that range, the distortion rises dramatically.

200 mm (8") coaxial loudspeakers

Figure 8A, B, and C show performance data on the unique JBL 8140 "Co-motional" 2-way design, while D, E, and F and G, H, and J show data, respectively, on the Soundolier C803 and the Altec 409-T.

While nearly all 200 mm coaxials have a stationary HF element located on a bridge which extends across the frame, the JBL 8140 has its HF element, a piezoelectric device, attached directly to the LF cone near its apex. This design eliminates interference in the crossover region due to the bridge, and the near-coincidence of both HF and LF elements results in a very smooth transition between the two, as can be seen from a comparison of the on-axis data for all three models.

The Co-motional design is subject to Doppler distortion while the two competitive models are not. We have assured ourselves that LF cone excursions normally encountered in distributed systems are small enough so that any modulation of the HF due to LF cone motion will be insignificant.

All the models exhibit smooth off-axis response since they all have the benefit of a separate small HF radiator.

Conclusion

With the new 8000-series industrial products line, JBL confirms its belief that quality performance in low-level distributed systems need not cost any more than the mediocre performance which has become the norm for this important segment of sound contracting work. JBL is further the only manufacturer of industrial grade loudspeakers to publish Thiele-Small parameters for these products, thus enabling contractors and consultants to custom design enclosures for optimum LF performance.

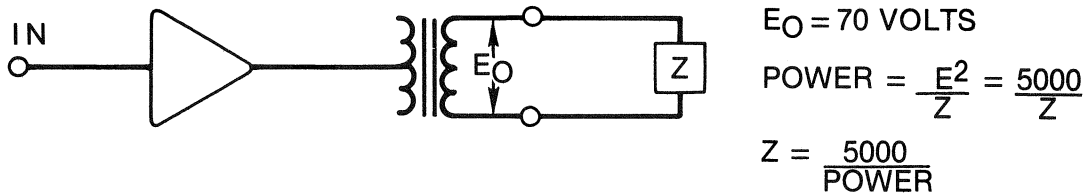

FIGURE 1. A 70-VOLT AMPLIFIER

TABLE I.

| POWER | Z |
|-------|--------|
| 50 W | 100 Ω |
| 100 W | 50 Ω |
| 200 W | 25 Ω |
| 250 W | 20 Ω |
| 400 W | 12.5 Ω |

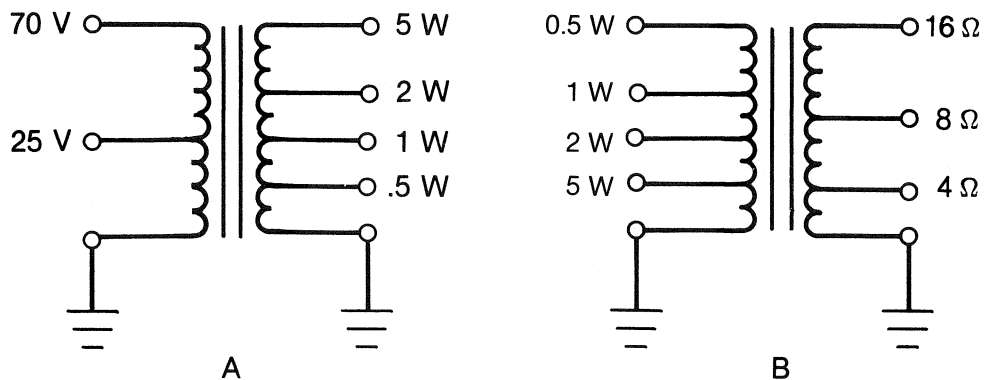
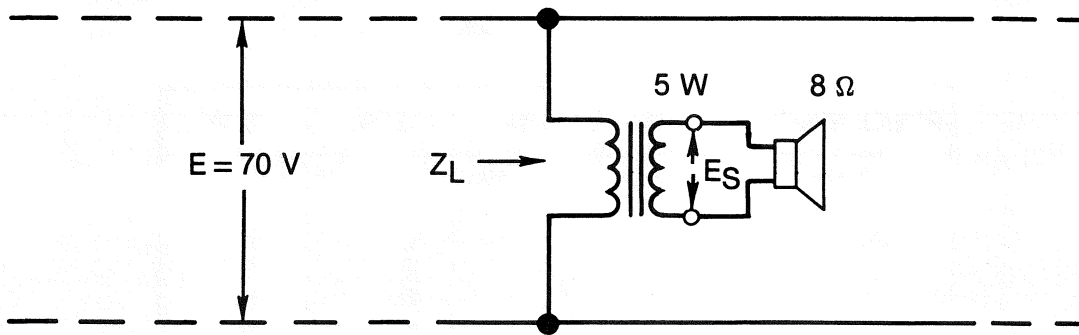

FIGURE 2. TYPICAL 70-VOLT DISTRIBUTION TRANSFORMERS



$$Z_L = \frac{5000}{5} = 1000 \Omega$$

$$E_S = \sqrt{PZ} = \sqrt{5(8)} = 6.3 \text{ V RMS}$$

FIGURE 3. PLACING A 5-WATT LOAD ACROSS A 70-VOLT LINE

TABLE II. INSERTION LOSS (70-VOLT PRIMARY) FOR JBL 9315HT TRANSFORMER

| TAP | TYPICAL | MAXIMUM | DRAWS FROM LINE | DELIVERS TO LOAD |
|-------|---------|---------|-----------------|------------------|
| 5 W | 1.0 dB | 1.25 dB | 5 W | 4 W |
| 2 W | 0.7 dB | 1.0 dB | 2 W | 1.7 W |
| 1 W | 0.7 dB | 1.0 dB | 1 W | 0.85 W |
| 0.5 W | 1.0 dB | 1.25 dB | 0.5 W | 0.4 W |

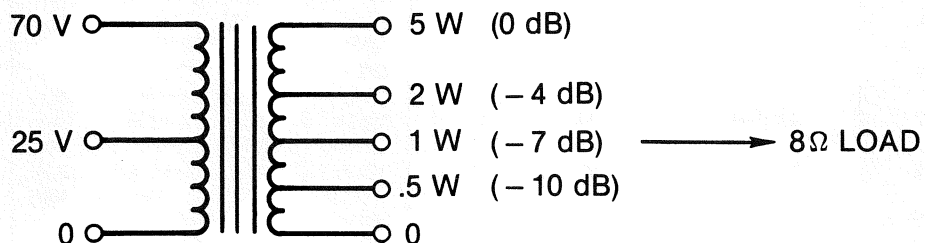

FIGURE 4. JBL MODEL 9315HT TRANSFORMER

TABLE III. JBL MODEL 9315HT

| FREQUENCY | 0.5 W | 1 W | 2 W | 5 W |
|-----------------------------|----------|----------|----------|--------|
| 40 Hz | -0.1 dB* | -0.1 dB* | -0.1 dB* | 0 dB* |
| 60 | -0.1 | 0 | -0.1 | 0 |
| 200 | -0.1 | 0 | 0 | 0 |
| 1 K | 0 | 0 | 0 | 0 |
| 2 K | 0 | 0 | 0 | 0 |
| 5 K | 0 | 0 | 0 | 0 |
| 8 K | -.05 | -.1 | -0.12 | -0.15 |
| 10 K | -.05 | -.13 | -0.19 | -0.23 |
| 12 K | -.15 | -.165 | -0.23 | -0.31 |
| INSERTION LOSS, 1 kHz | 1.1 dB | 0.6 dB | 0.5 dB | 0.9 dB |
| THD @ 40 Hz, 5 WATTS = 0.9% | | | | |

*DATA NORMALIZED TO 1 kHz

TABLE IV. SOUNDOLIER MODEL HT-47

| FREQUENCY | 0.5 W | 1 W | 2 W | 4W |
|----------------------------|---------|----------|-----------|-----------|
| 40 Hz | 0 dB* | 0 dB* | -0.12 dB* | -0.55 dB* |
| 60 | 0 | 0 | 0 | 0 |
| 200 | 0 | 0 | 0 | 0 |
| 1 K | 0 | 0 | 0 | 0 |
| 2 K | 0 | 0 | 0 | 0 |
| 5 K | -0.1 | -0.16 | -0.25 | -0.26 |
| 8 K | -0.3 | -0.43 | -0.5 | -0.55 |
| 10 K | -0.6 | -0.67 | -0.8 | -0.8 |
| 12 K | -0.8 | -0.95 | -1.1 | -1.1 |
| INSERTION LOSS, 1 kHz | 0.85 dB | -0.45 dB | -1.4 dB | -1.1 dB |
| THD @ 40 Hz, 4 WATTS = 15% | | | | |

*DATA NORMALIZED TO 1 kHz

TABLE V. MAXIMUM WIRE RUNS FOR 0.5 dB LOSS IN 70-VOLT SYSTEMS

| WIRE SIZE, AWG | RESISTANCE PER 300 m (1000') PAIR OF COPPER WIRE | MAXIMUM CURRENT | MAXIMUM POWER | 50 W | 100 W | 200 W | 250 W | 400W |
|----------------|--|-----------------|---------------|---------------|---------------|--------------|--------------|--------------|
| 10 | 2.0 OHMS | 25 AMP. | 1750 W | 870 m (2900') | 435 m (1450') | 220 m (730') | 175 m (580') | 110 m (370') |
| 12 | 3.2 OHMS | 20 AMP. | 1400 W | 545 m (1820') | 272 m (910') | 140 m (460') | 110 m (365') | 70 m (230') |
| 14 | 5.2 OHMS | 15 AMP. | 1000 W | 335 m (1120') | 168 m (560') | 85 m (280') | 68 m (225') | 42 m (140') |
| 16 | 8.0 OHMS | 6 AMP. | 420 W | 220 m (740') | 110 m (370') | 55 m (180') | 45 m (150') | 27 m (90') |
| 18 | 13.0 OHMS | 3 AMP. | 210 W | 170 m (560') | 85 m (280') | --- | --- | --- |
| 20 | 20.6 OHMS | 1 AMP. | 70 W | 66 m (220') | 33 m (110') | --- | --- | --- |

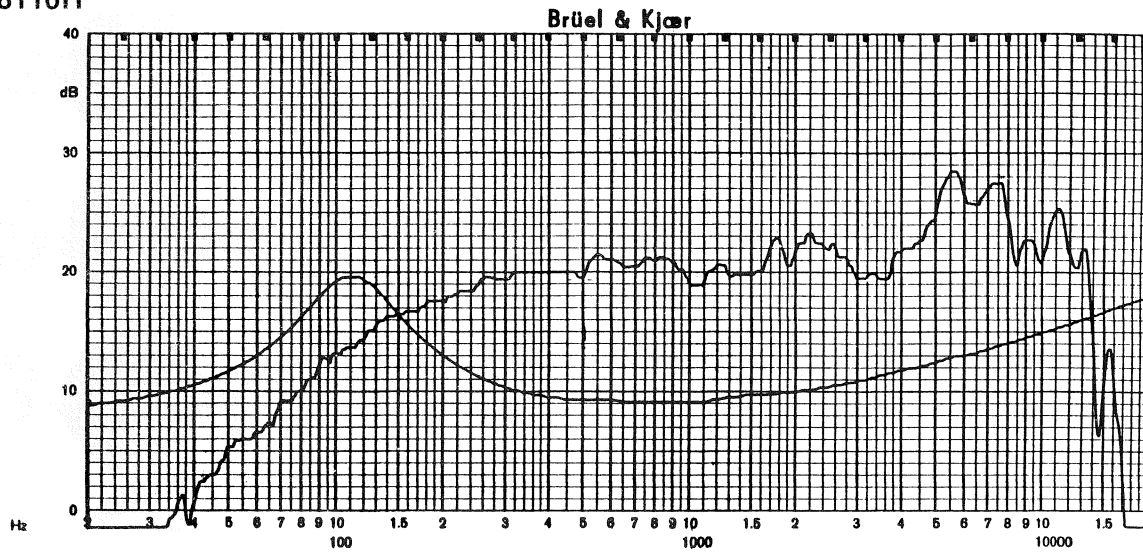

FIGURE 5A

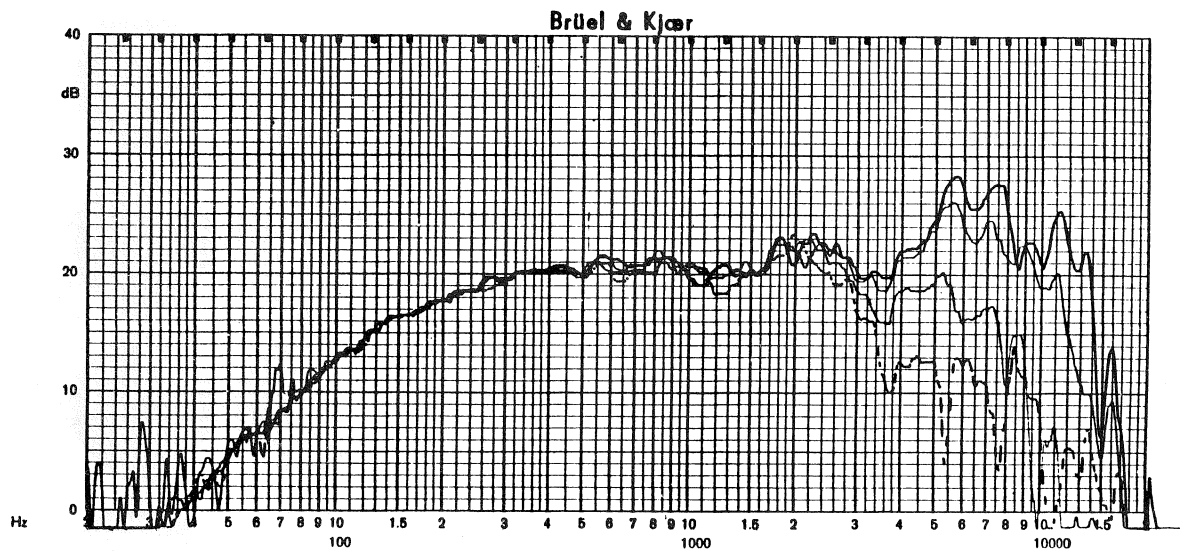

FIGURE 5B

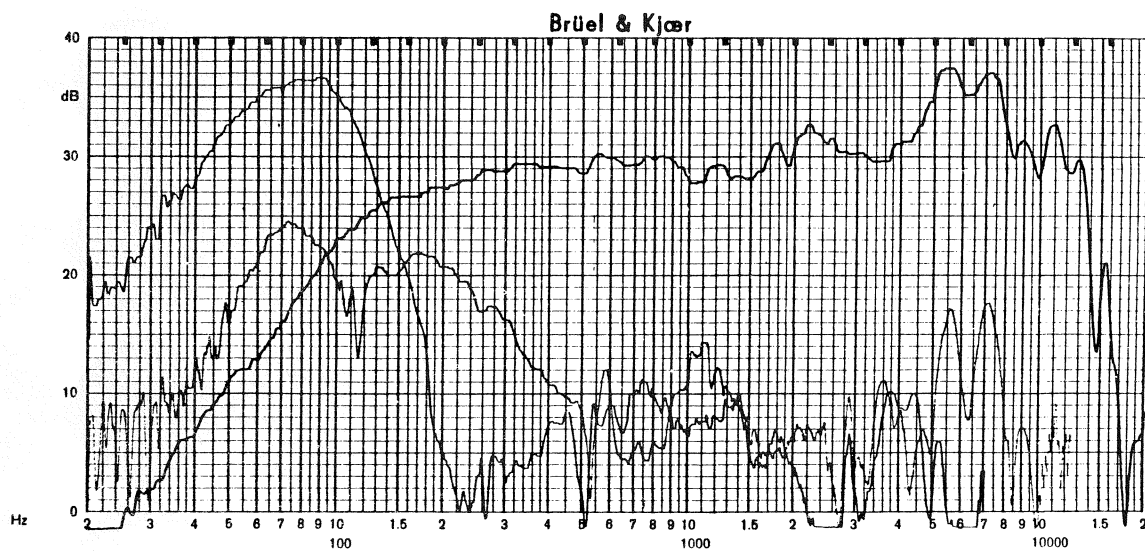

FIGURE 5C

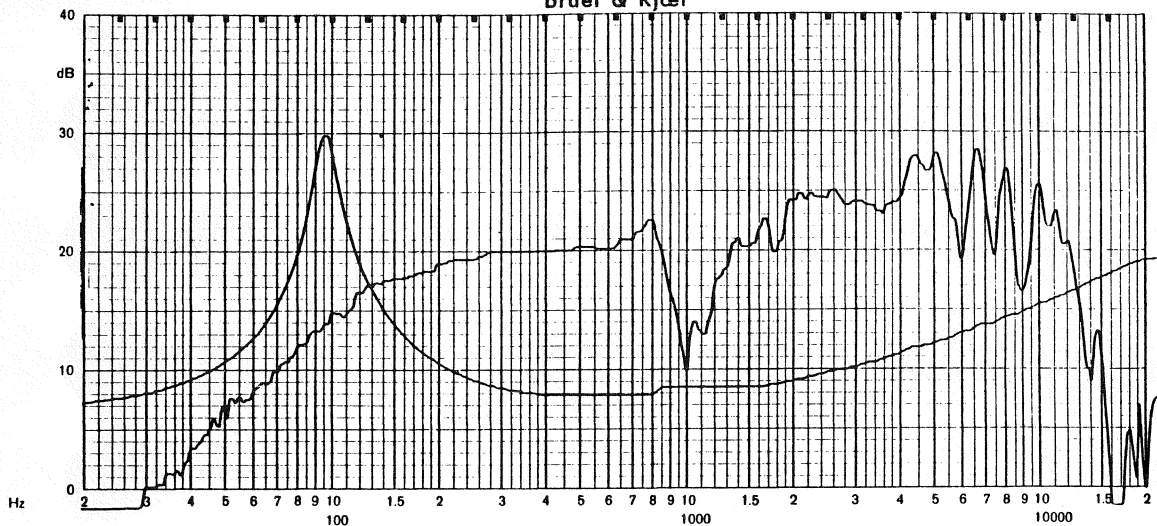

FIGURE 5D

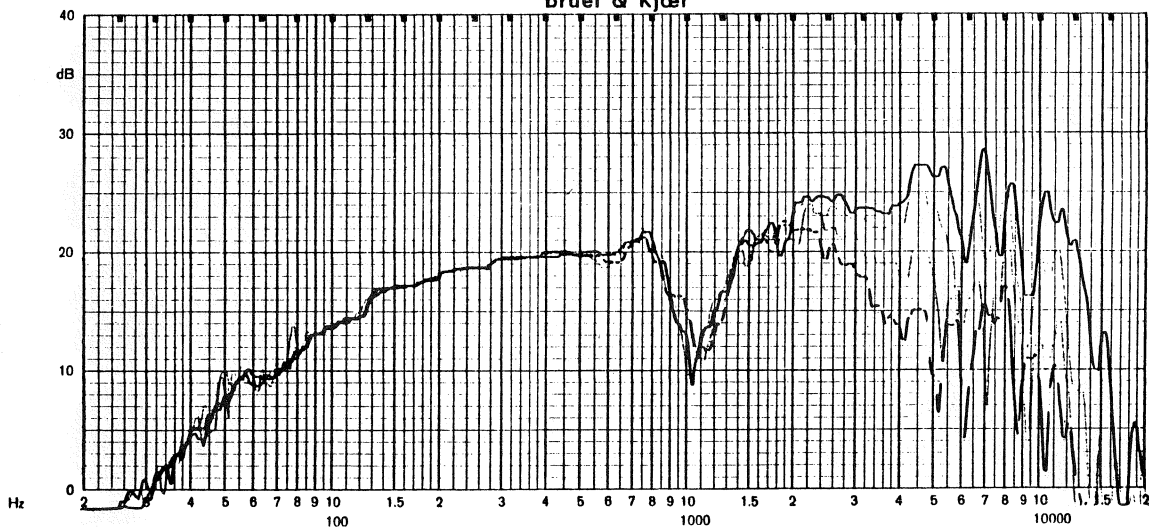
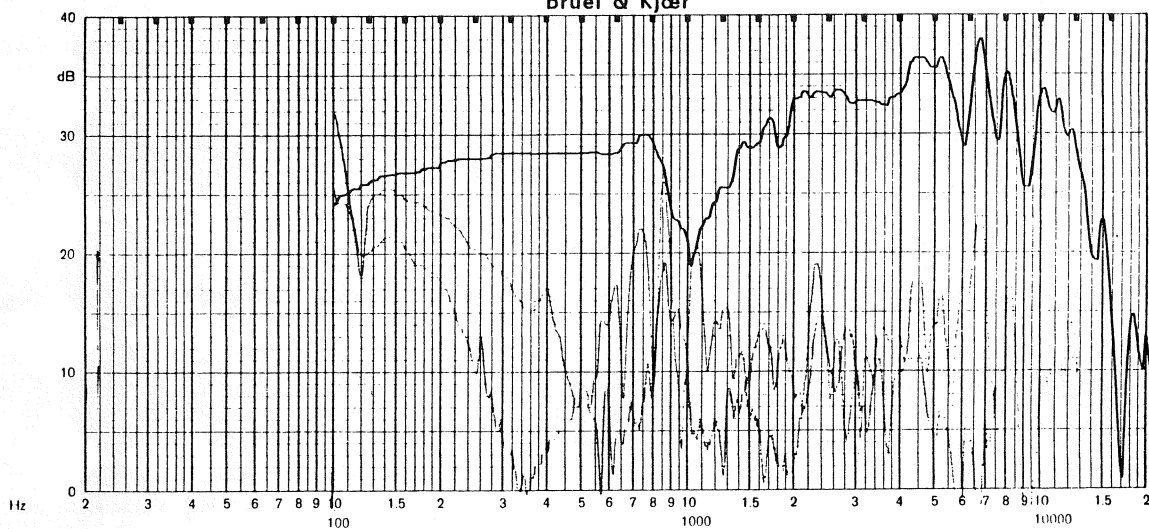

FIGURE 5E



Brüel & Kjær

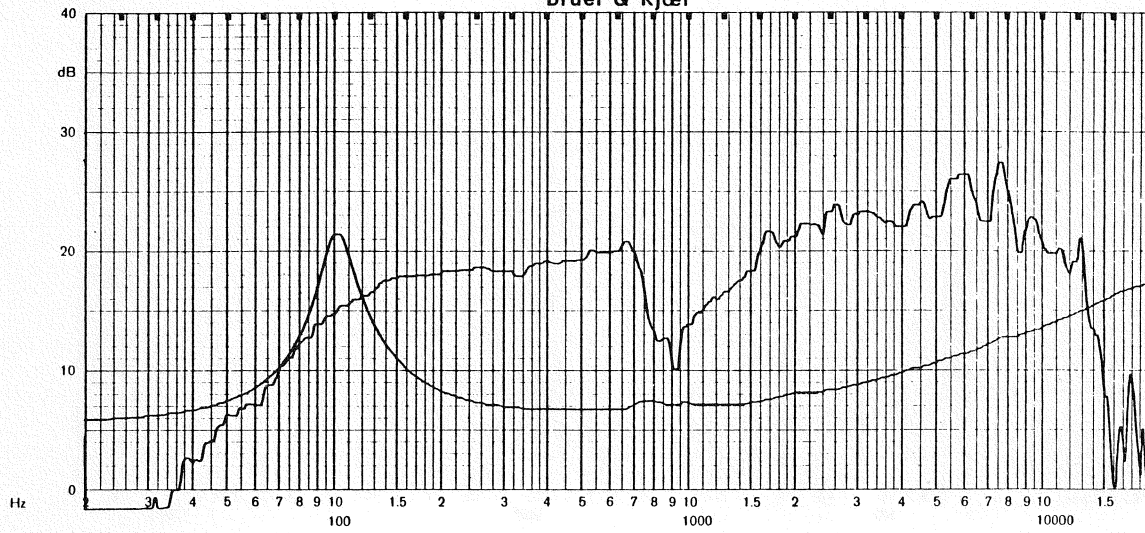

FIGURE 5G

Brüel & Kjær

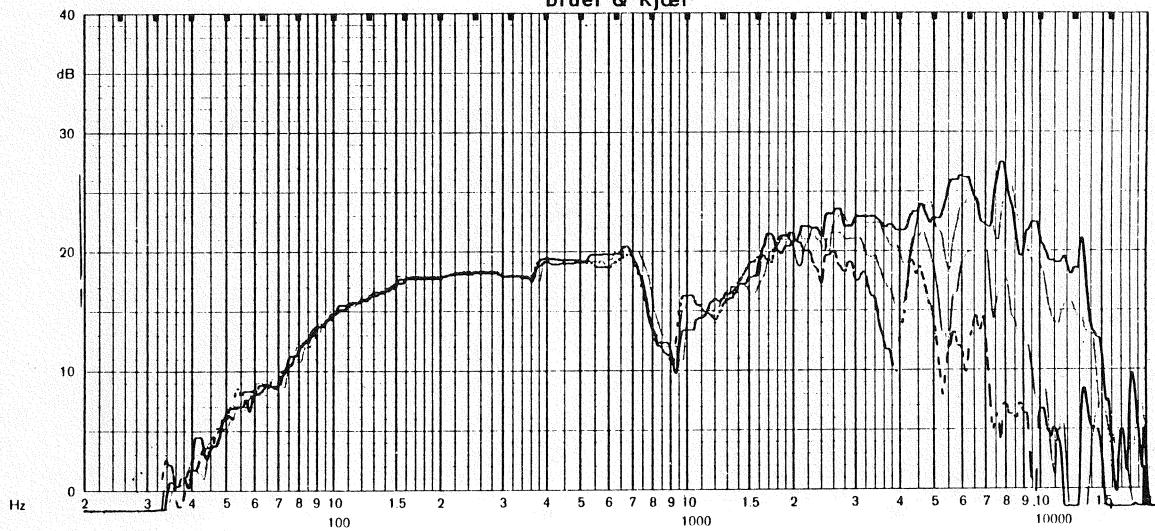

FIGURE 5H

Brüel & Kjær

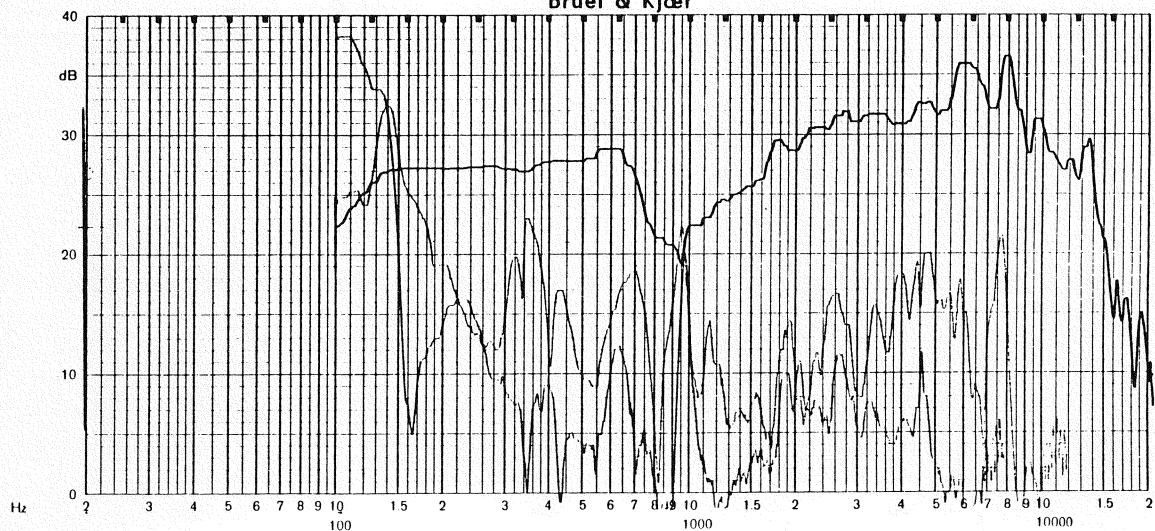

FIGURE 5J

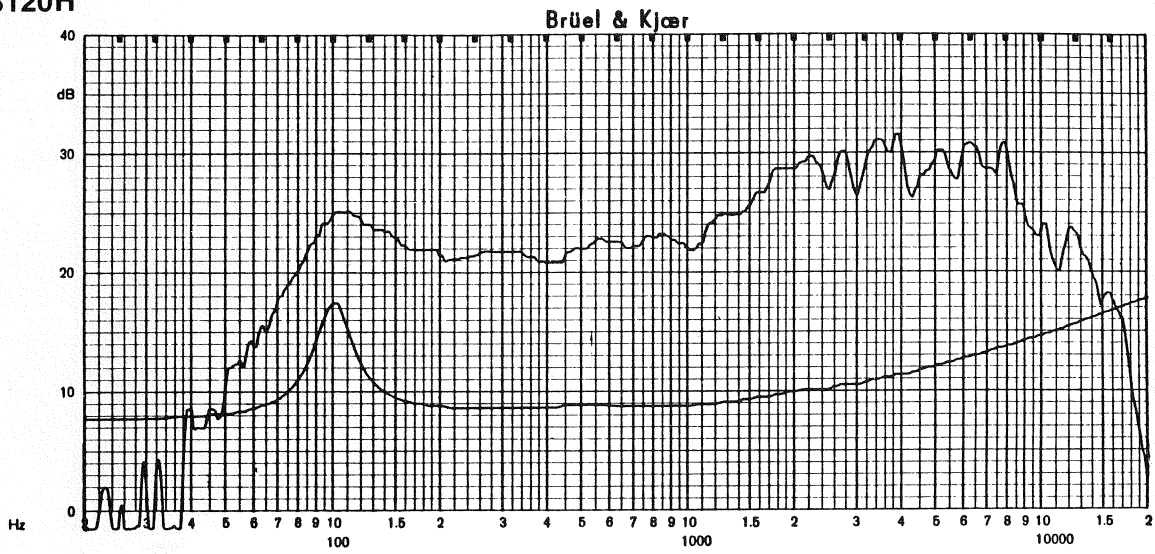

FIGURE 6A

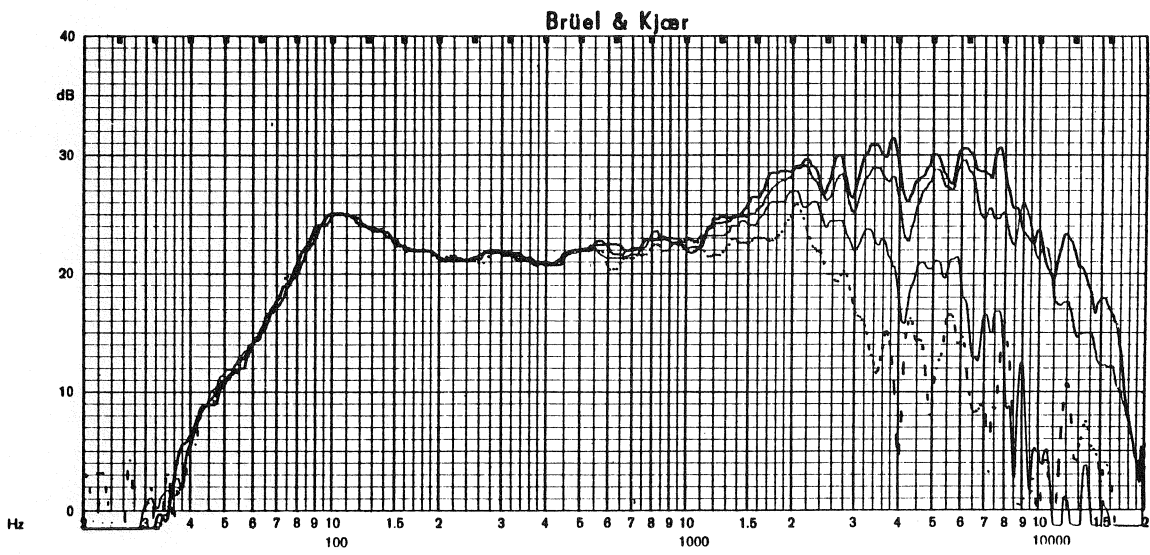

FIGURE 6B

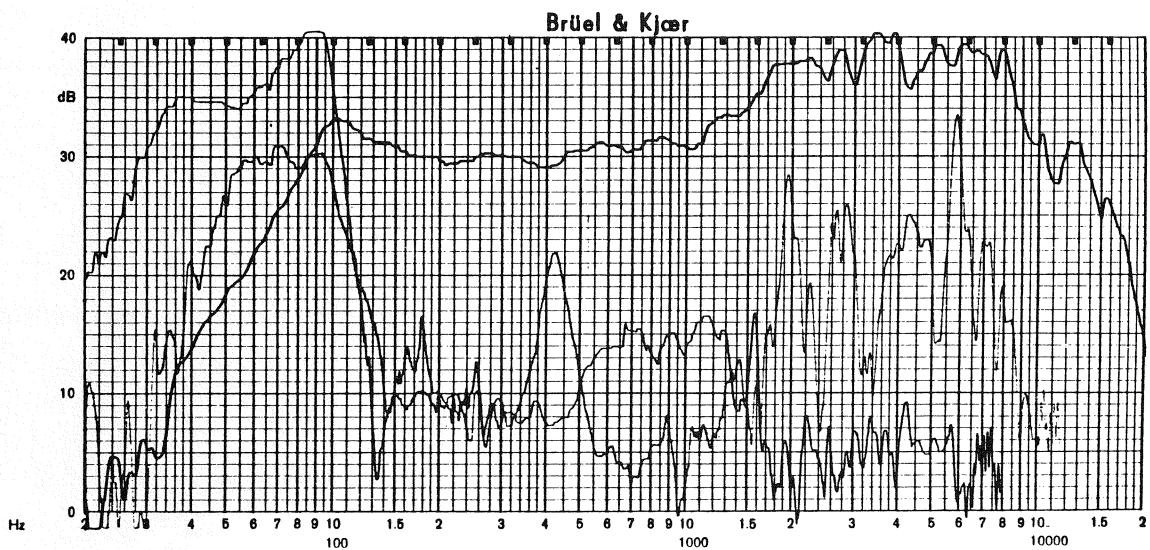

FIGURE 6C

SOUNDOLIER FD

Brüel & Kjær

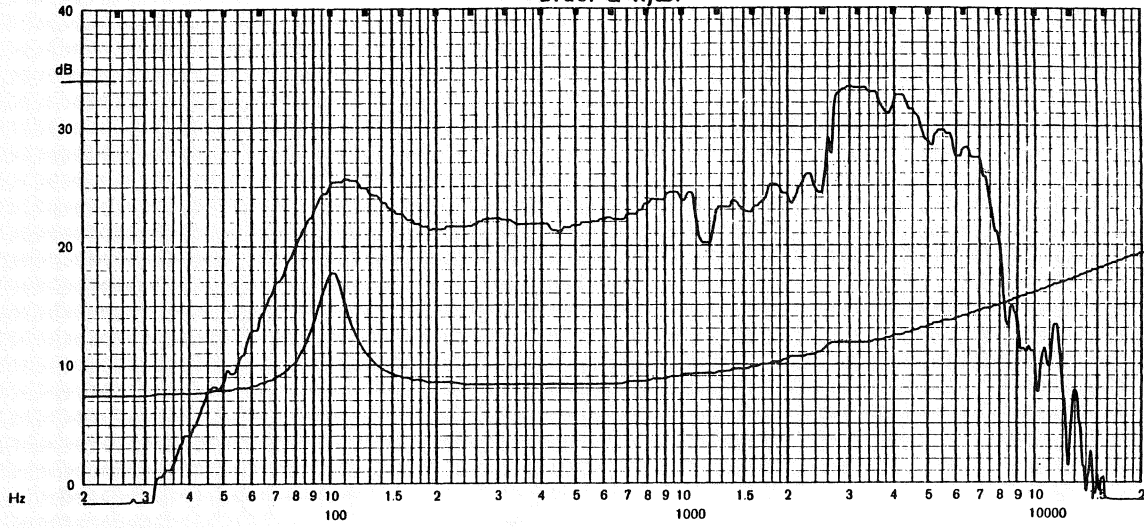

FIGURE 6D

Brüel & Kjær

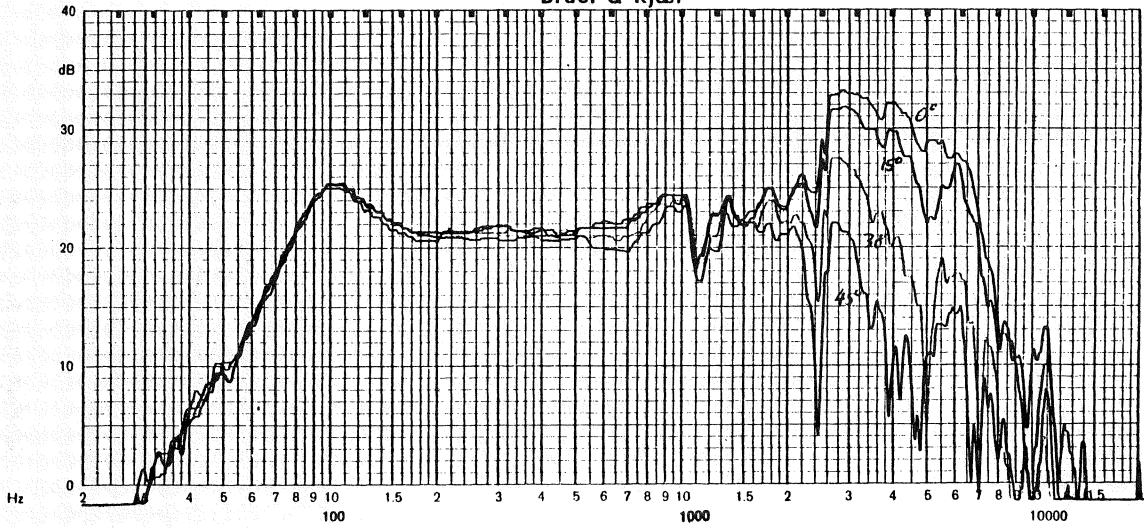

FIGURE 6E

Brüel & Kjær

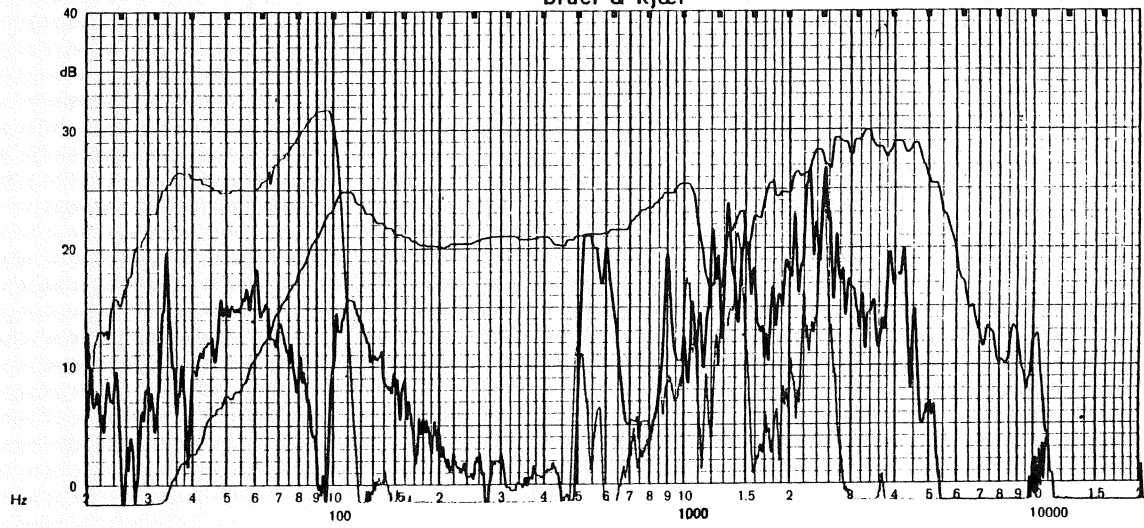

FIGURE 6F

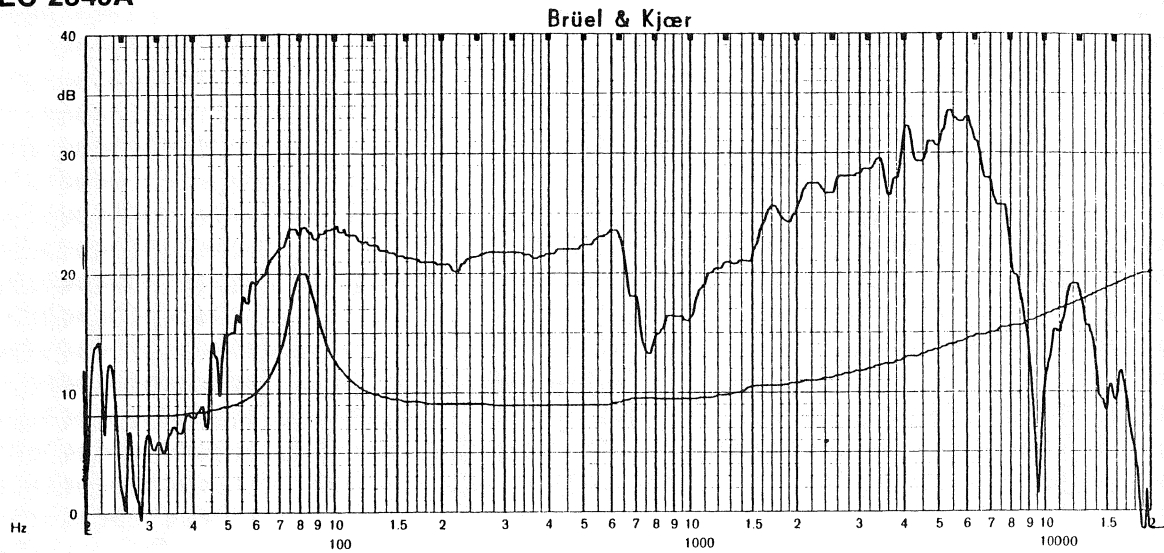

FIGURE 6G

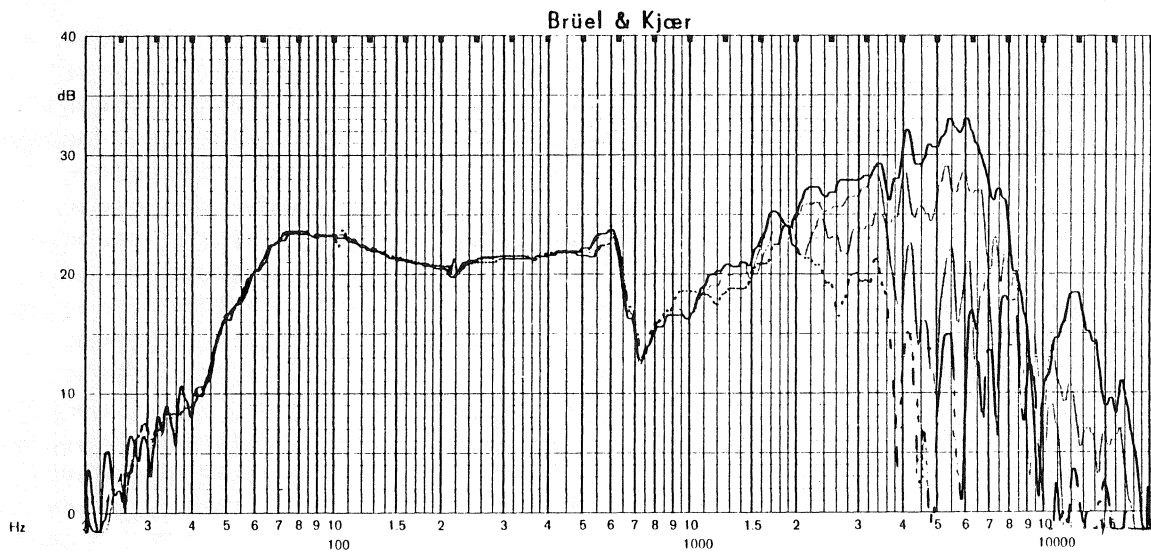

FIGURE 6H

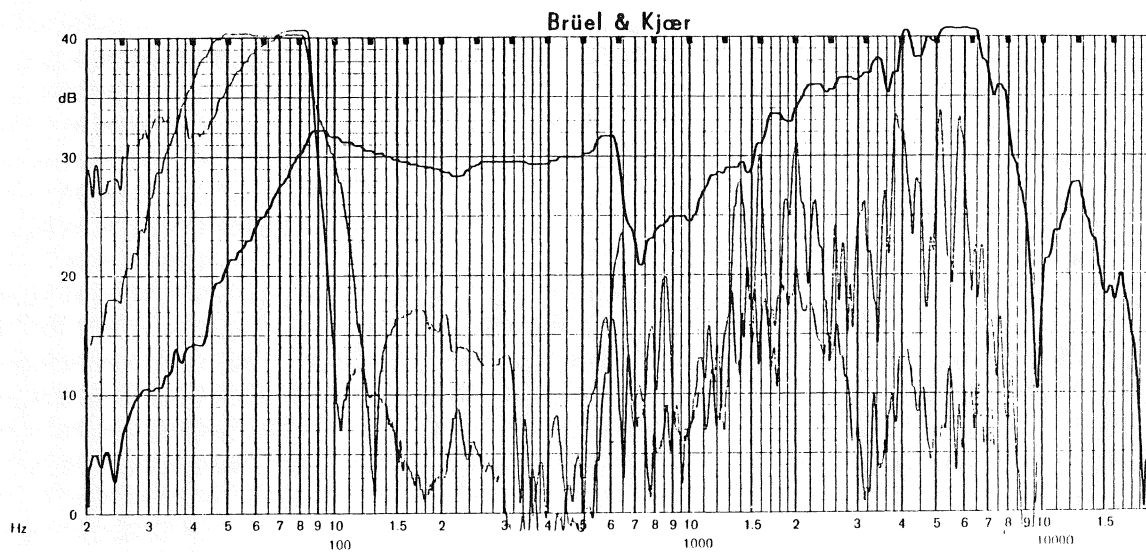

FIGURE 6J

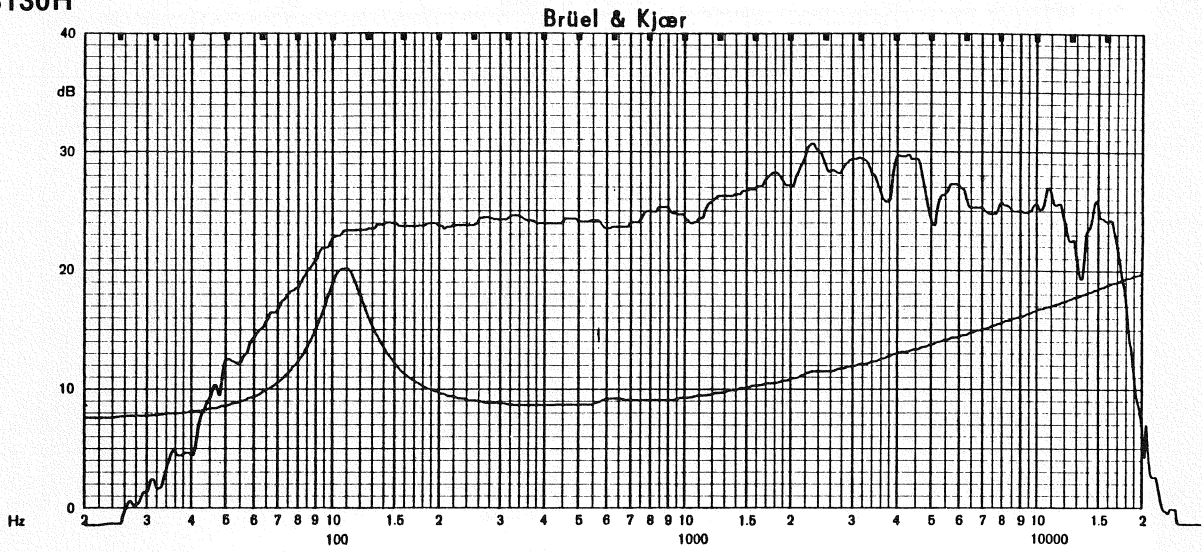

FIGURE 7A

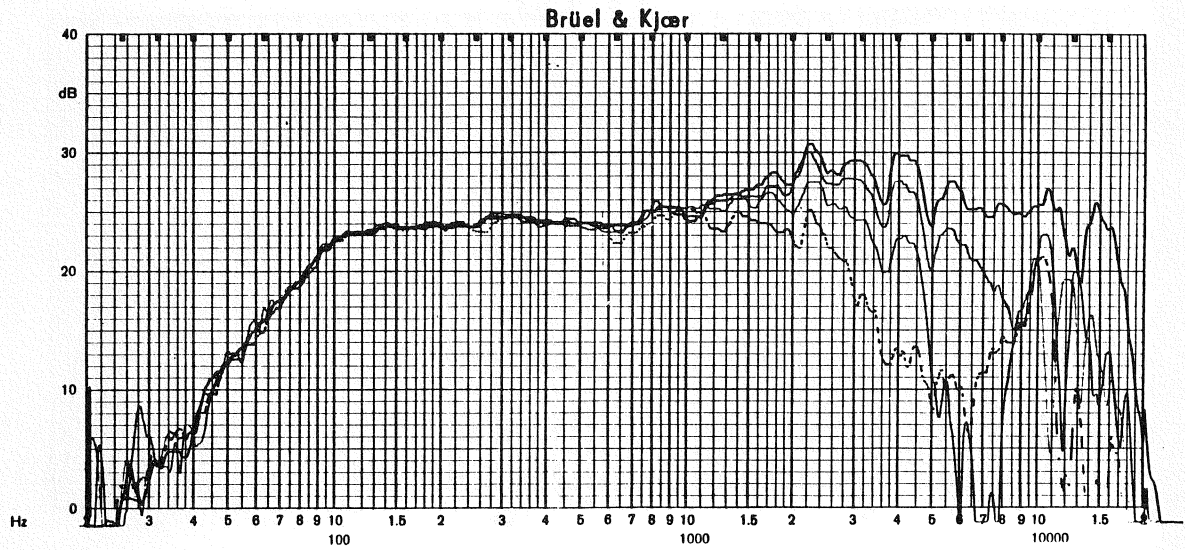

FIGURE 7B

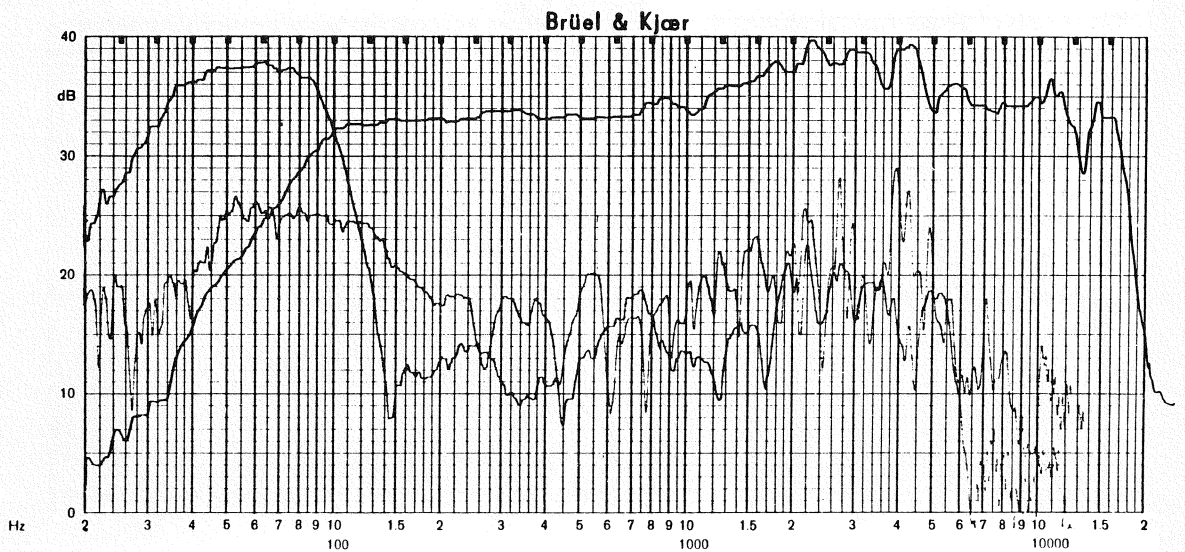

FIGURE 7C



FIGURE 7D

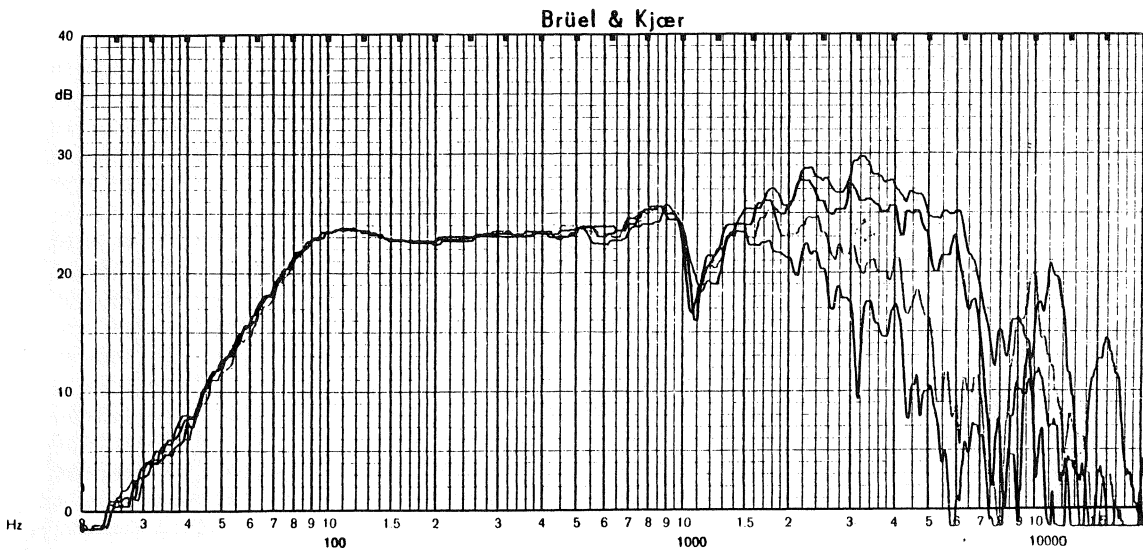

FIGURE 7E

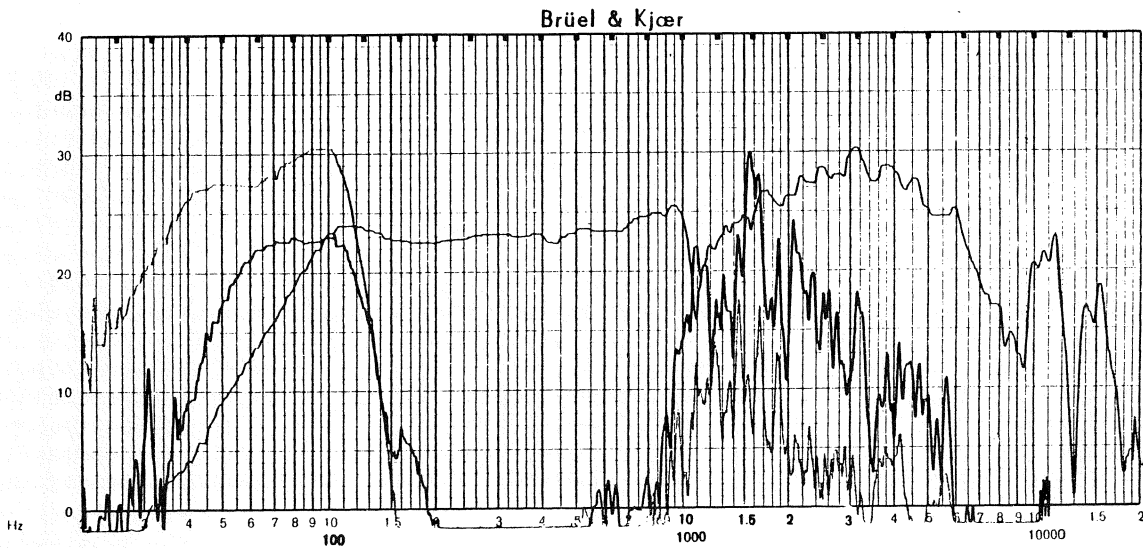

FIGURE 7F

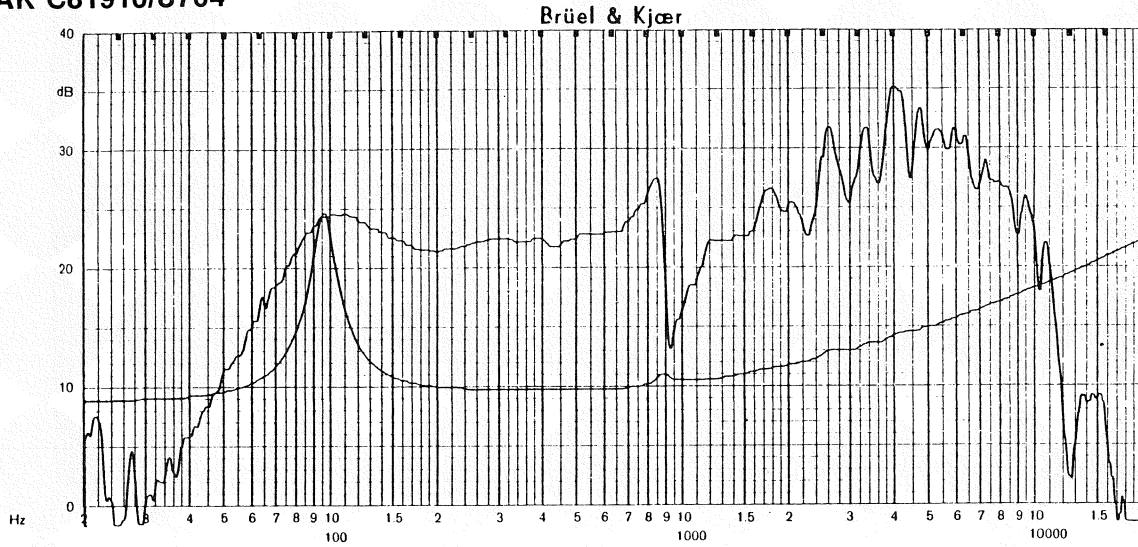

FIGURE 7G

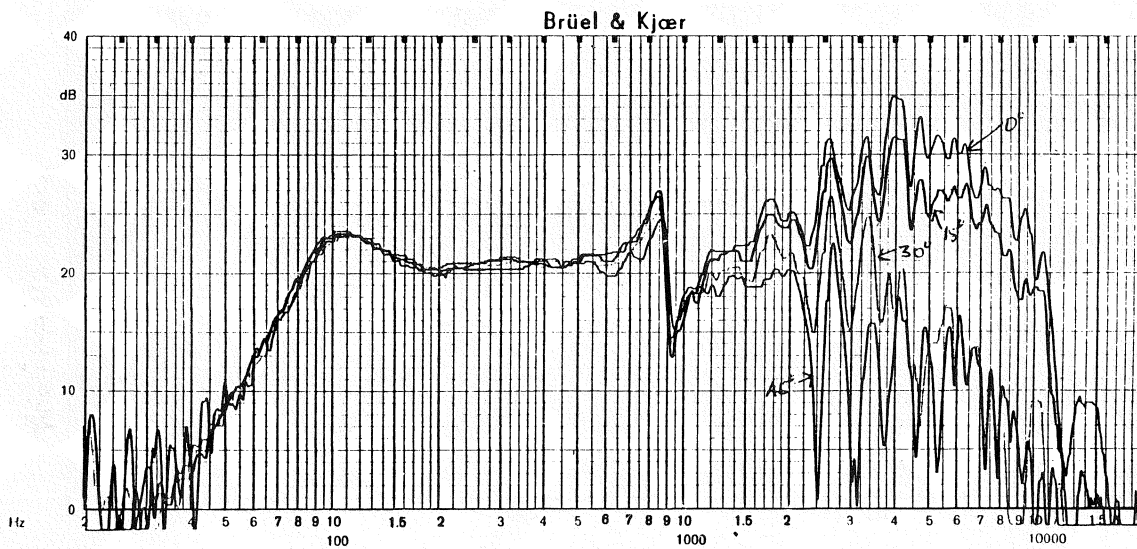

FIGURE 7H

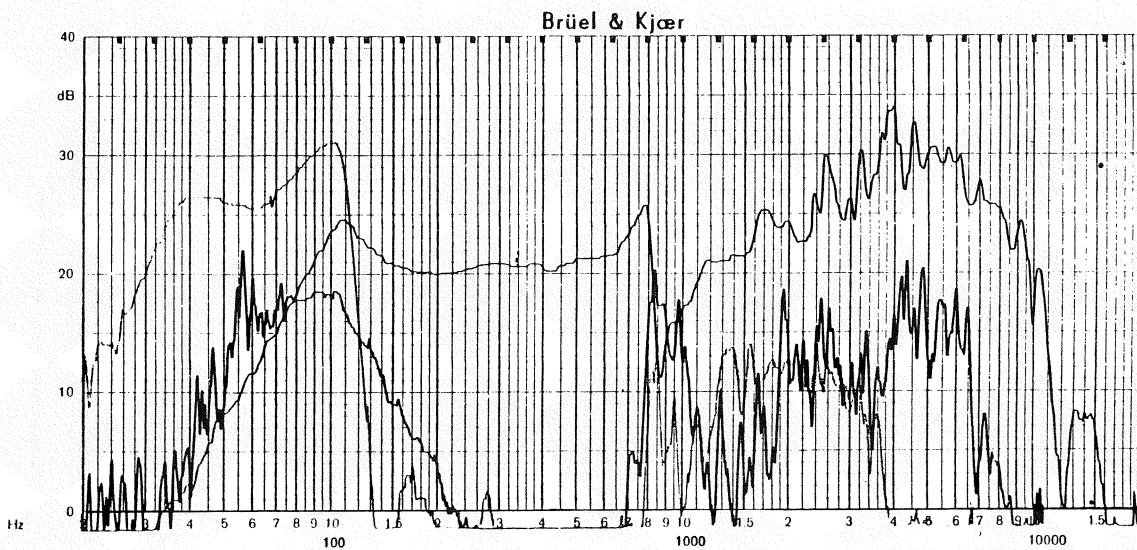

FIGURE 7J

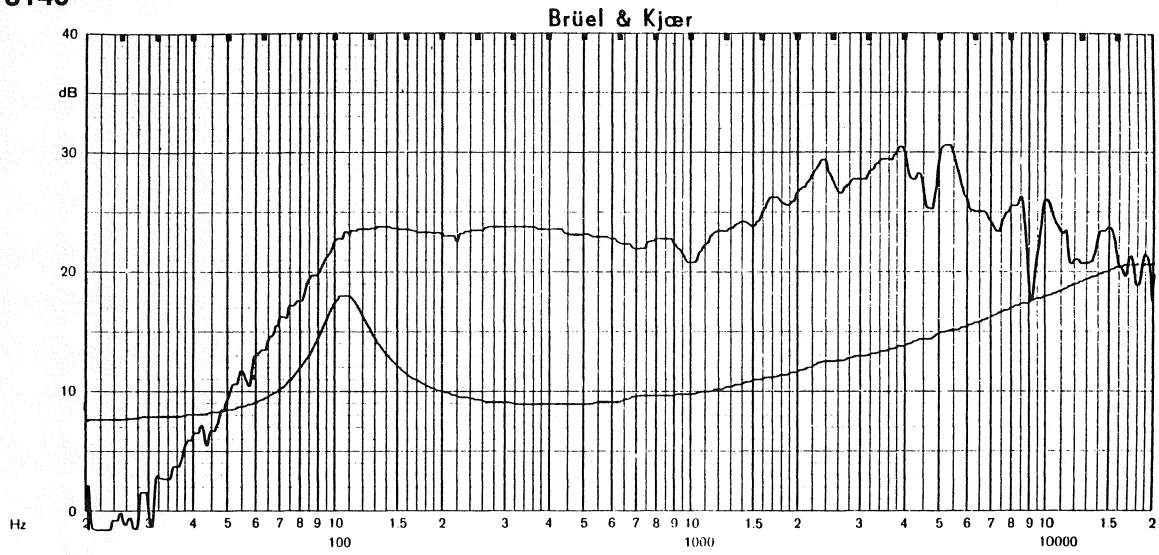

FIGURE 8A

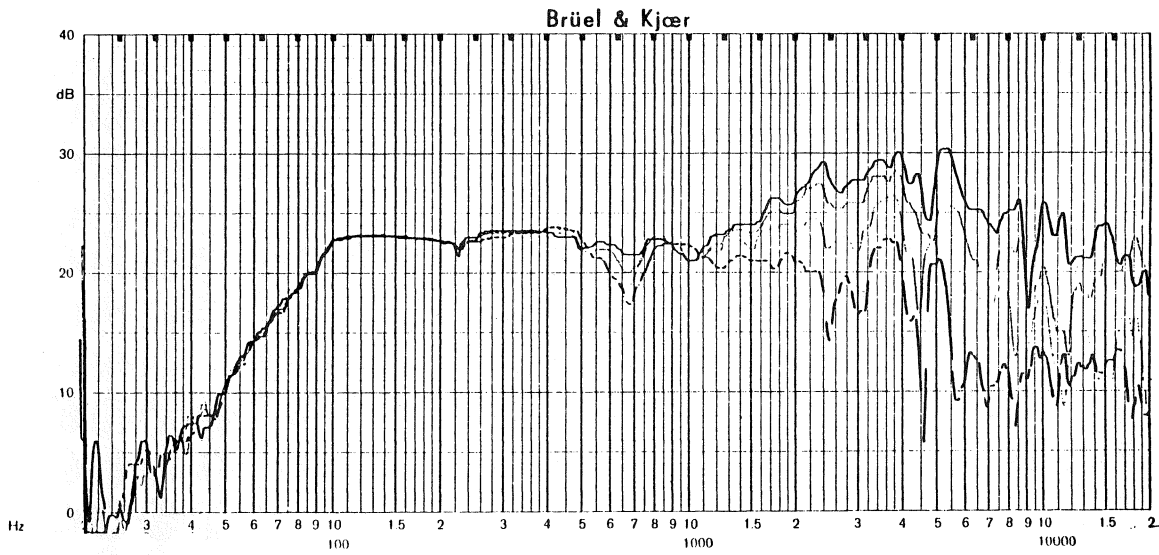

FIGURE 8B

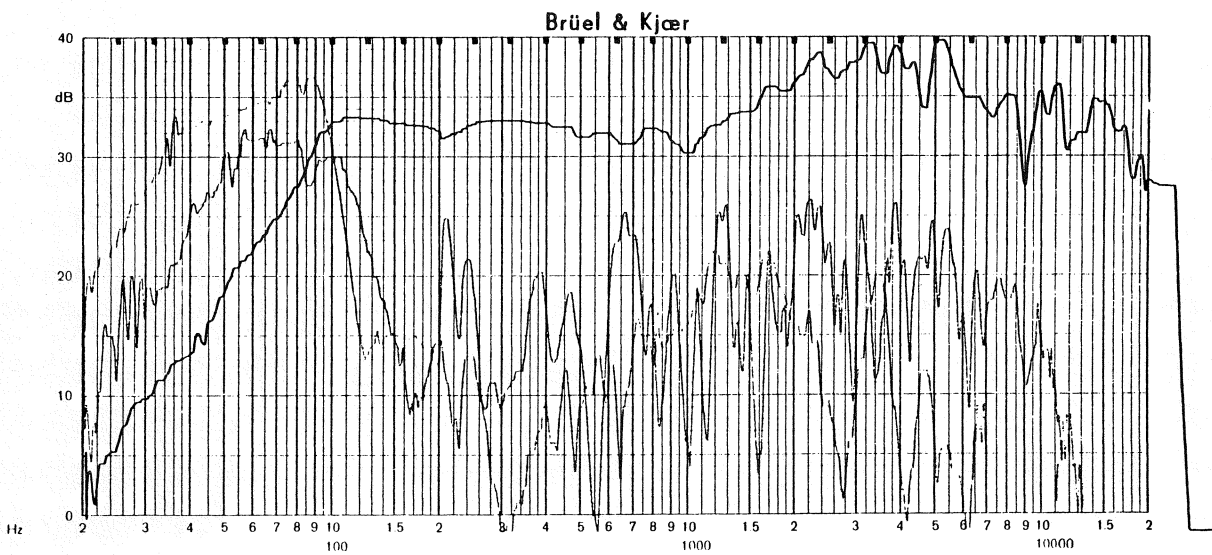

FIGURE 8C

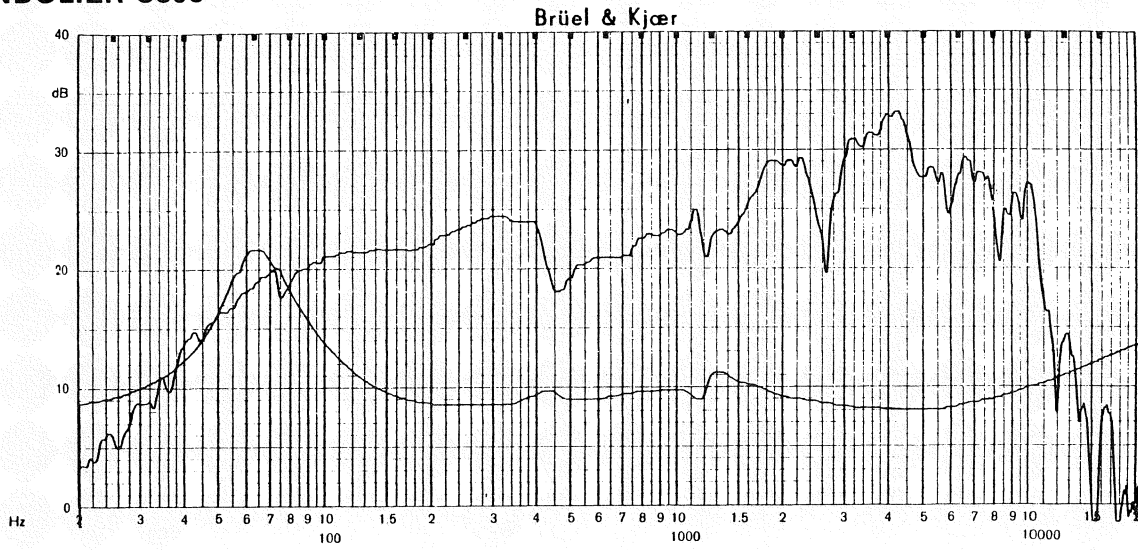

FIGURE 8D

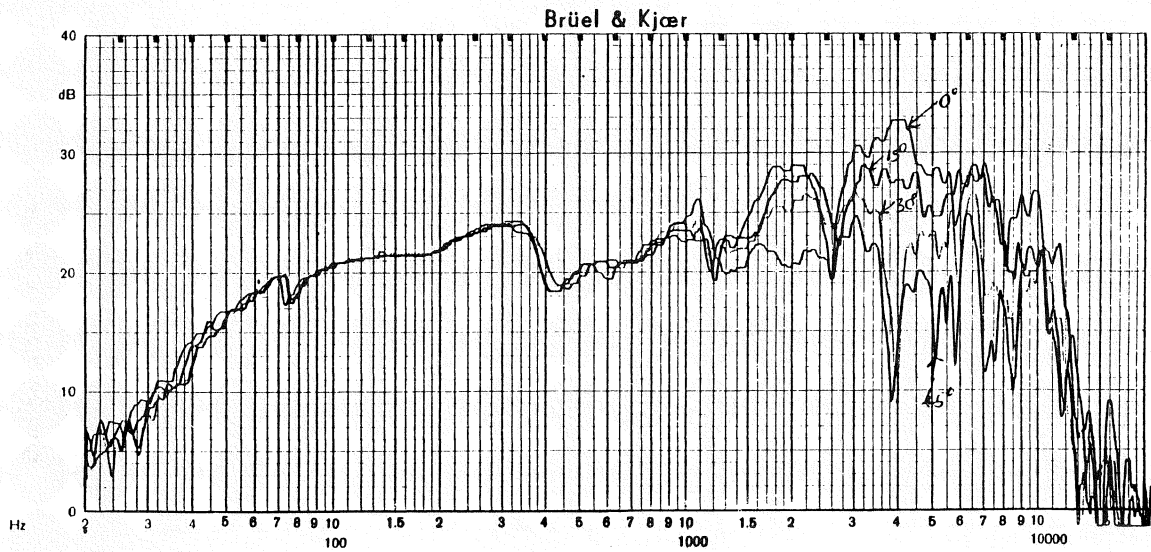

FIGURE 8E

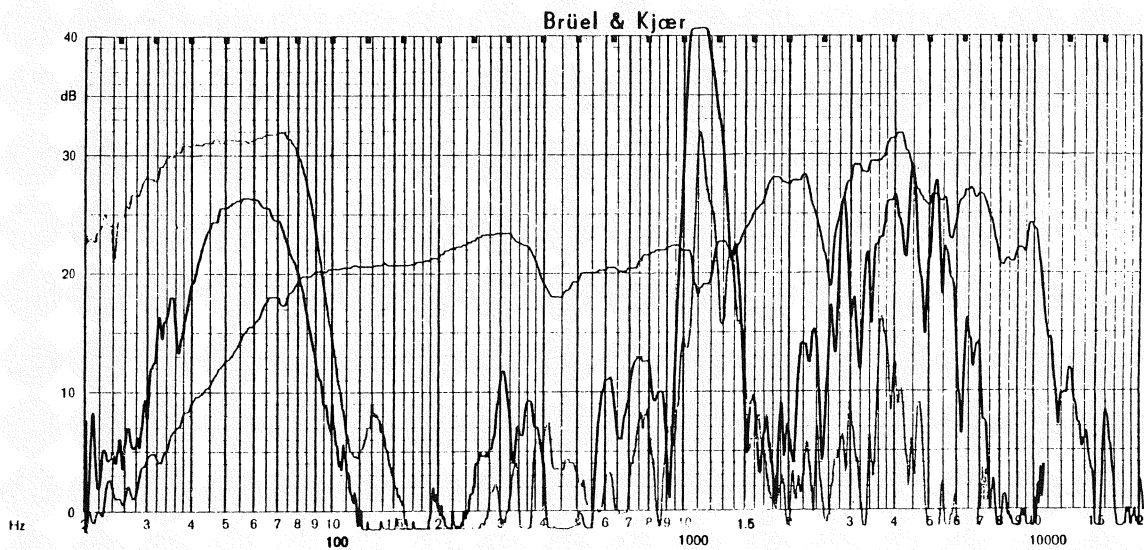

FIGURE 8F

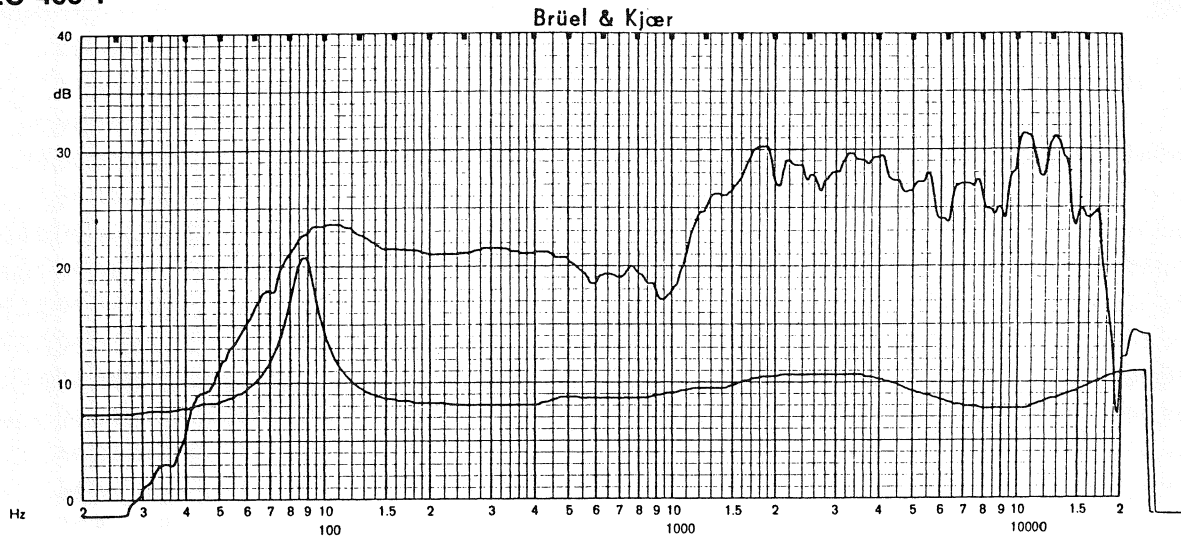

FIGURE 8G

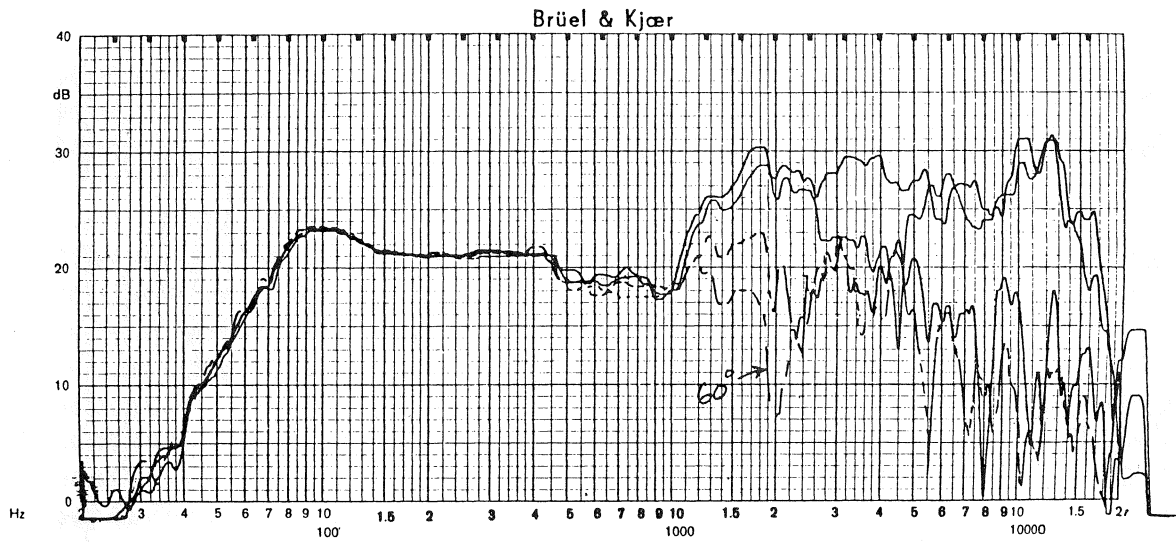

FIGURE 8H

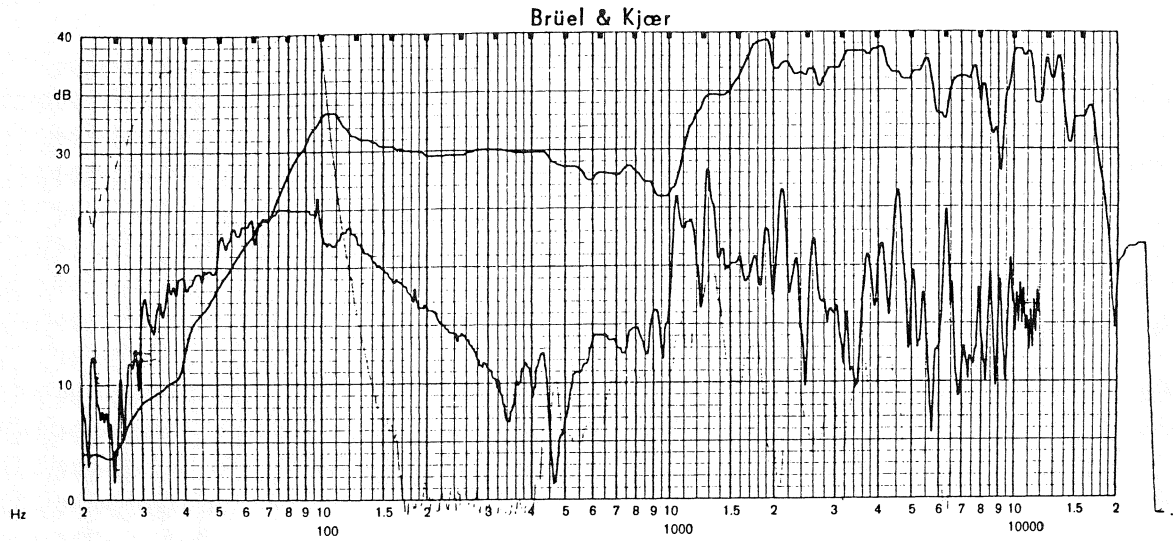

FIGURE 8J

NOTES



**PROFESSIONAL
DIVISION**

JBL Incorporated, 8500 Balboa Boulevard, P.O. Box 2200, Northridge, California 91329 U.S.A.

JBL/harman international
2M 63810 6/84 Printed in U.S.A.